

Article number: 204250M1280D3S

Description: E+G levelling foot
GN 42-50-M12-80-D3-S

Note: S Without nut, External hexagon at the bottom

Measures

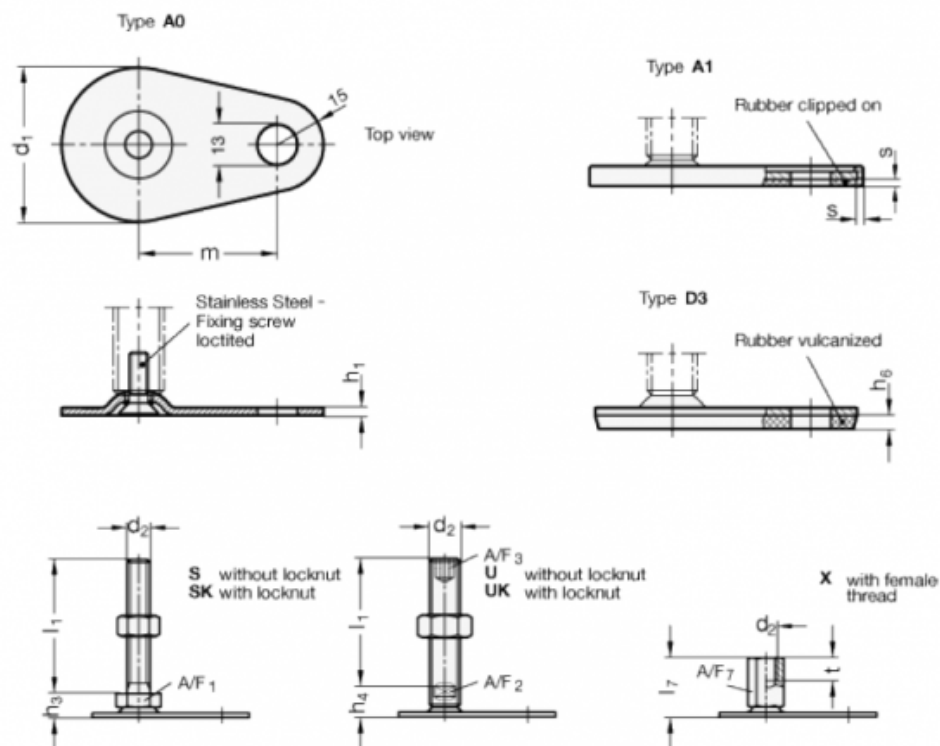

A/F1 = 17

d1 = 50

d2 = M12

h1 = 2.5

h3 = 11

h6 = 4

l1 = 80

m = 45

s =